

RAUCH

Phone: (718) 507-8844 Fax: (718) 565-6018

Email: info@irauch.com

Address: 32-20 112th St, East Elmhurst, NY 11369

Fig 124 KT

RAUCH ADJUSTABLE SADDLE PIPE SUPPORT KIT

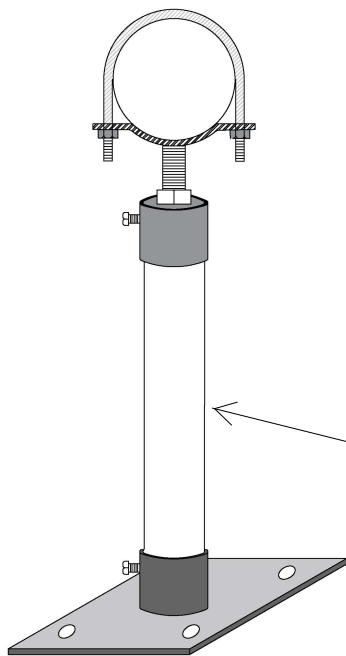

Saddle assembly with 8" threaded rod for up to 6" adjustment

8" x 8" x 1/4" Base plate assembly

Available materials:

Plain - Black

Electro galvanized

Painted

other finishes/material upon request

Extension 2" pipe supplied by customer (field cut to suit)

Available for pipe sizes 2" - 16"